

L字パーテーション 図

(S=1/30)

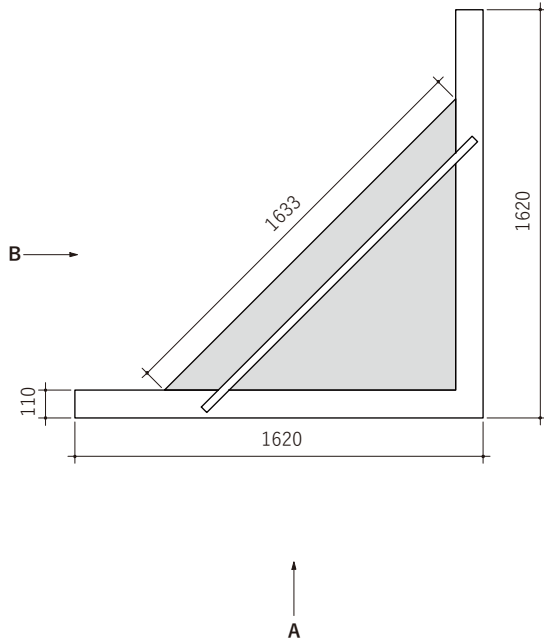

平面図

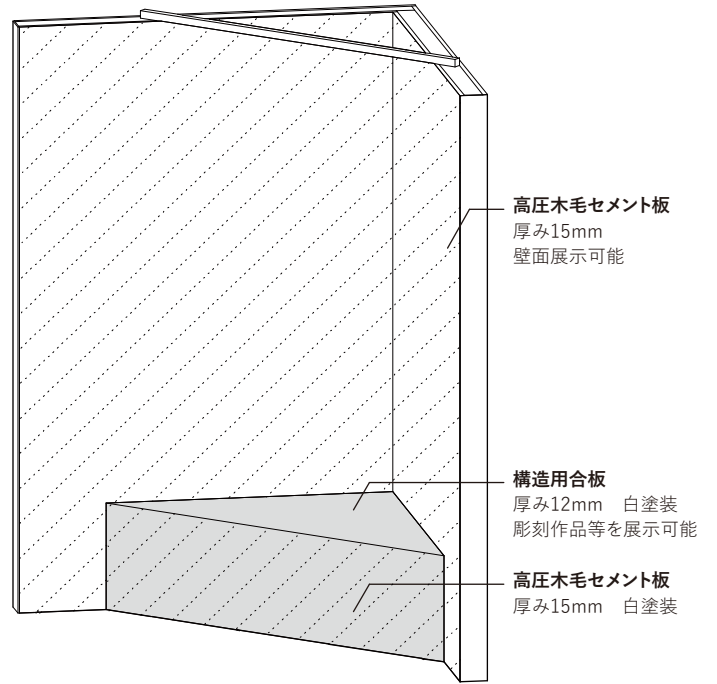

全体図

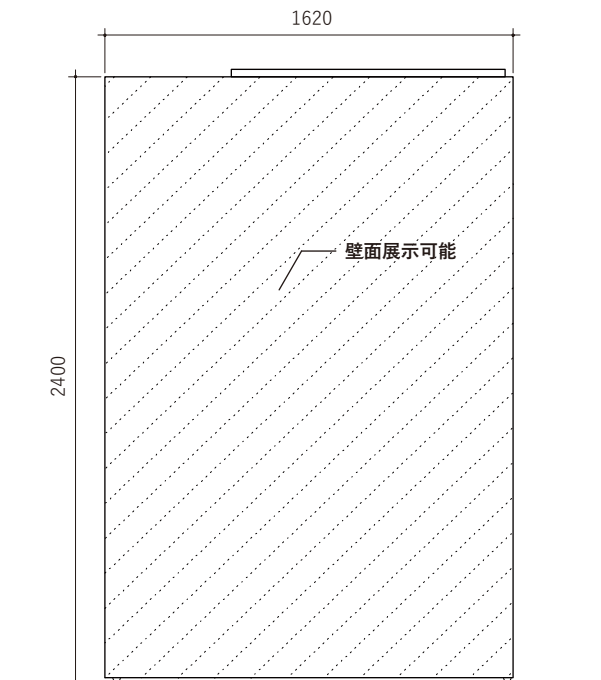

A正面図

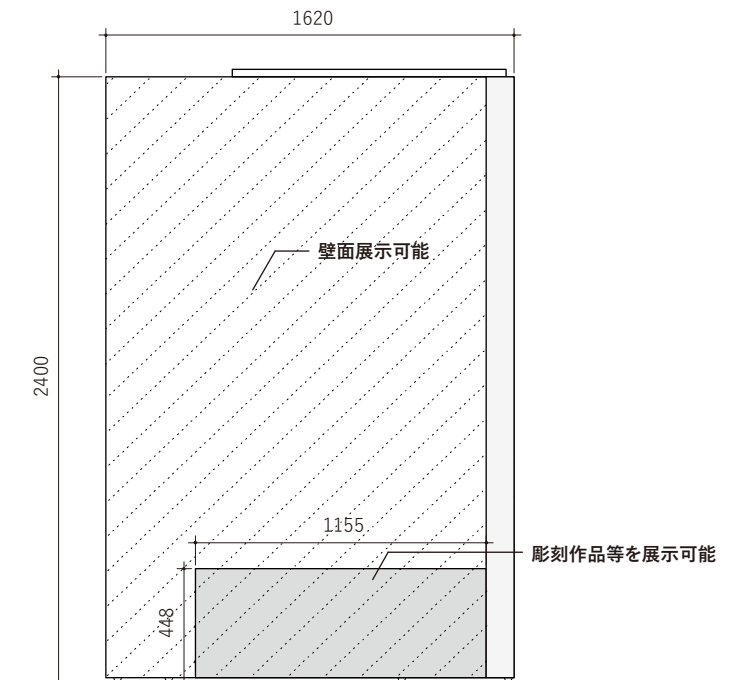

B正面図

L字パーティション 組合せ例

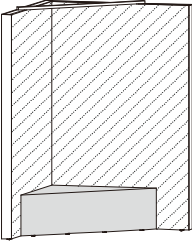
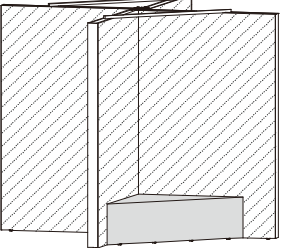
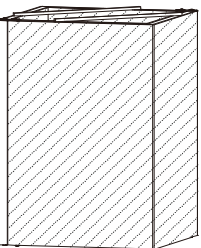
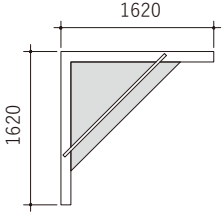
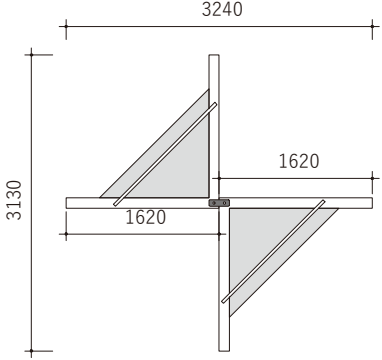
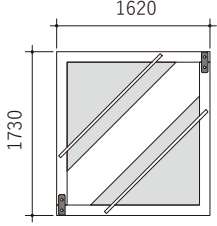
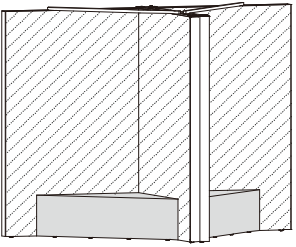
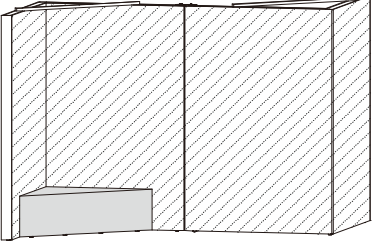
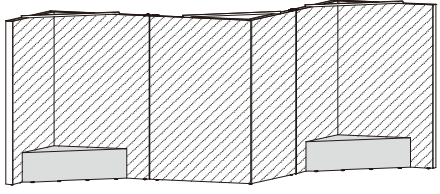
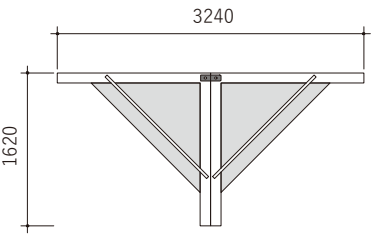
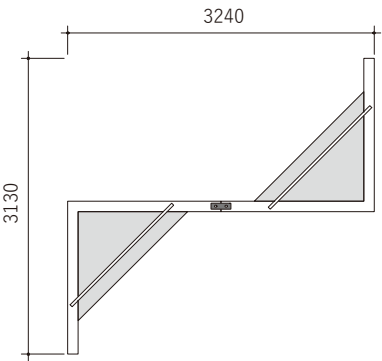
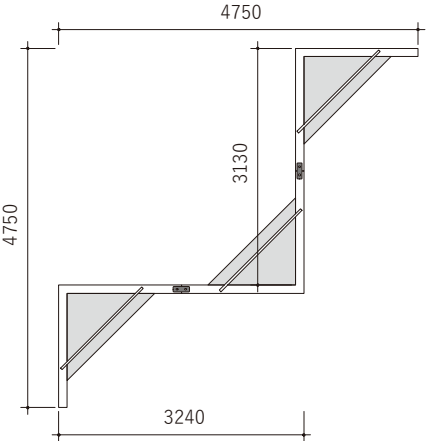
組合せ1	組合せ2	組合せ3
<p>全体図</p> 	<p>全体図</p> 	<p>全体図</p> 
<p>平面図</p>  <p style="text-align: right;">壁面高:2400mm</p>	<p>平面図</p>  <p style="text-align: right;">壁面高:2400mm</p>	<p>平面図</p>  <p style="text-align: right;">壁面高:2400mm</p>
組合せ4	組合せ5	組合せ6
<p>全体図</p> 	<p>全体図</p> 	<p>全体図</p> 
<p>平面図</p>  <p style="text-align: right;">壁面高:2400mm</p>	<p>平面図</p>  <p style="text-align: right;">壁面高:2400mm</p>	<p>平面図</p>  <p style="text-align: right;">壁面高:2400mm</p>

L字パーティション 配置例

配置1

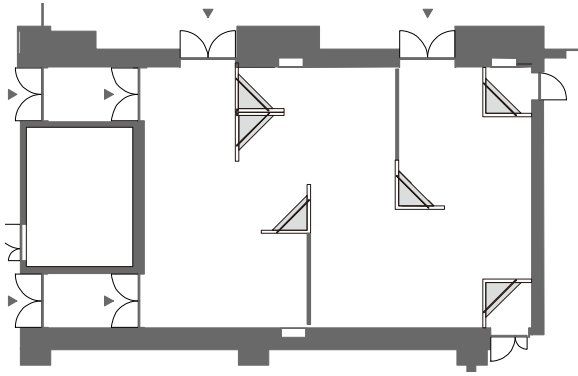

配置2

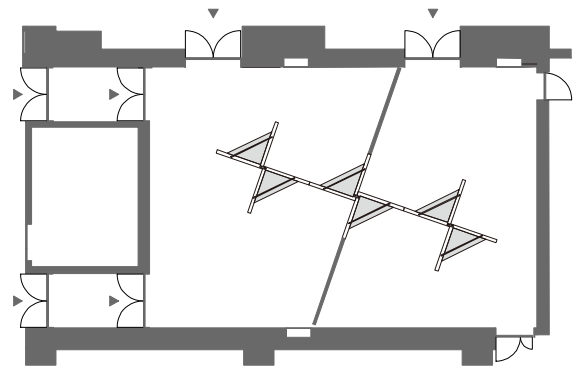

配置3

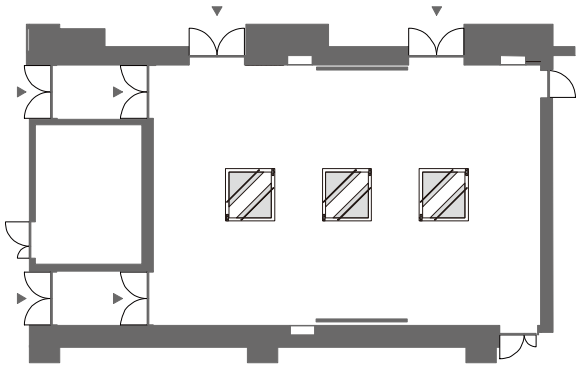

配置4

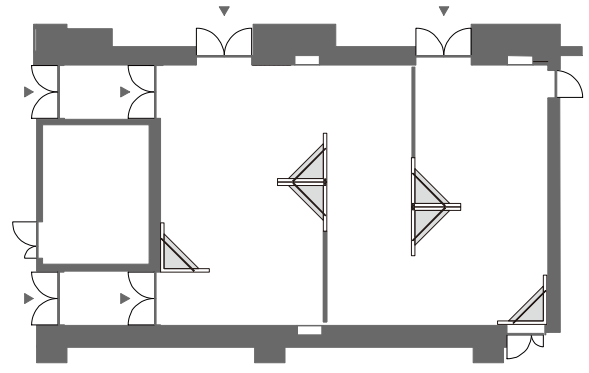

配置5

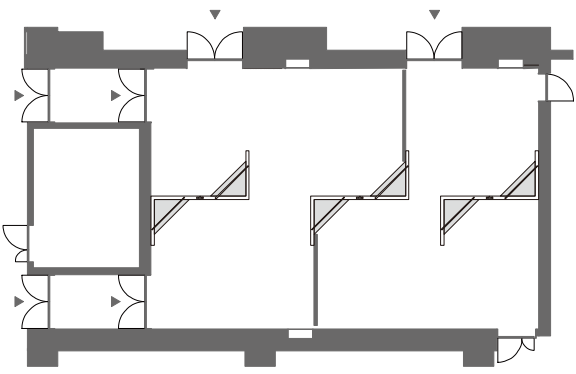

配置6

